

XCMD2115L1

 limit switch XCMD - thermoplastic roller lever -
 1NC+1NO - snap - 1 m

Main

Range of product	OsiSense XC
Series name	Standard format
Product or component type	Limit switch
Device short name	XCMD
Sensor design	Miniature
Body type	Fixed
Head type	Rotary head
Material	Metal
Body material	Zamak
Head material	Zamak
Fixing mode	By the body
Movement of operating head	Rotary
Type of operator	Spring return roller lever thermoplastic
Type of approach	Lateral approach 2 directions
Number of poles	2
Contacts type and composition	1 NC + 1 NO
Contact operation	Snap action

Complementary

Tracks	24/31 mm
Switch actuation	By 30° cam
Electrical connection	Removable cable connector
Cable length	1 m
Cable composition	5 x 0.75 mm ²
Wire insulation material	PvR
Contacts insulation form	Zb
Positive opening	With
Positive opening minimum force	0.5 N
Minimum force for tripping	0.1 N
Maximum actuation speed	1.5 m/s
Contact code designation	B300, AC-15 (U _e = 240 V, I _e = 1.5 A) conforming to EN/IEC 60947-5-1 appendix A R300, DC-13 (U _e = 250 V, I _e = 0.1 A) conforming to EN/IEC 60947-5-1 appendix A
[Ui] rated insulation voltage	300 V degree of pollution 3 conforming to UL 508 400 V degree of pollution 3 conforming to IEC 60947-5-1 300 V degree of pollution 3 conforming to CSA C22.2 No 14
Resistance across terminals	<= 25 MOhm conforming to IEC 60255-7 category 3
[Uimp] rated impulse withstand voltage	4 kV conforming to IEC 60664 4 kV conforming to IEC 60947-1
Short-circuit protection	6 A by gG cartridge fuse
Electrical durability	5000000 cycles, DC-13, 120 V, 1 W, operating rate: <= 60 cyc/mn, load factor: 0.5 conforming to IEC 60947-5-1 appendix C 5000000 cycles, DC-13, 24 V, 3 W, operating rate: <= 60 cyc/mn, load factor: 0.5 conforming to IEC 60947-5-1 appendix C 5000000 cycles, DC-13, 48 V, 2 W, operating rate: <= 60 cyc/mn, load factor: 0.5 conforming to IEC 60947-5-1 appendix C

The information provided in this documentation contains general descriptions and/or technical characteristics of the performance of the products contained herein. This documentation is not intended as a substitute for and is not to be used for determining suitability or reliability of these products for specific user applications. It is the duty of any such user or integrator to perform the appropriate and complete risk analysis, evaluation and testing of the products with respect to the relevant specific application or use thereof. Neither Schneider Electric Industries SAS nor any of its affiliates or subsidiaries shall be responsible or liable for misuse of the information contained herein.

Mechanical durability	10000000 cycles
Width	30 mm
Height	50 mm
Depth	16 mm
Product weight	0.22 kg

Environment

shock resistance	25 gn (duration = 18 ms) conforming to IEC 60068-2-27
vibration resistance	5 gn (f = 10...500 Hz) conforming to IEC 60068-2-6
IP degree of protection	IP68 conforming to IEC 60529 IP66 conforming to IEC 60529 IP67 conforming to IEC 60529
IK degree of protection	IK06 conforming to EN 50102
overvoltage category	Class I conforming to NF C 20-030 Class I conforming to IEC 61140
ambient air temperature for operation	-25...70 °C
ambient air temperature for storage	-40...70 °C
protective treatment	TC
product certifications	CCC CSA UL
standards	EN/IEC 60204-1 EN/IEC 60947-5-1 UL 508 CSA C22.2 No 14

Offer Sustainability

Sustainable offer status	Green Premium product
RoHS (date code: YYWW)	Compliant - since 1002 - Schneider Electric declaration of conformity
REACH	Reference not containing SVHC above the threshold
Product environmental profile	Available
Product end of life instructions	Need no specific recycling operations

Dimensions

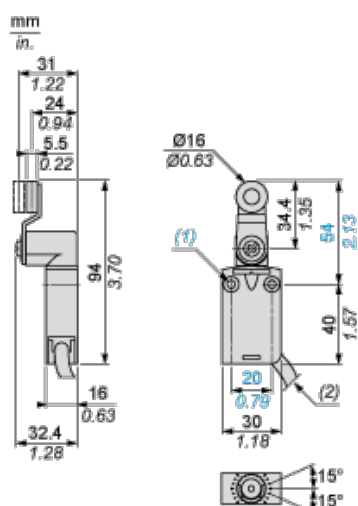

- (1) 2 fixing holes $\varnothing 4.2$ mm, counterbored $\varnothing 8$ mm by 4 mm deep.
(2) External diameter of cable 7.5 mm.

Mounting

Sweep of Connecting Cable

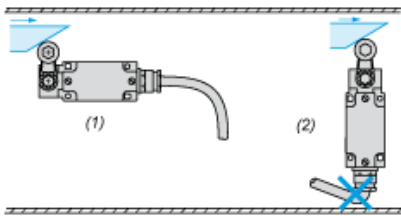

- (1) Recommended
- (2) To be avoided

Mounting with Rotary Heads and Levers

Type of Cam

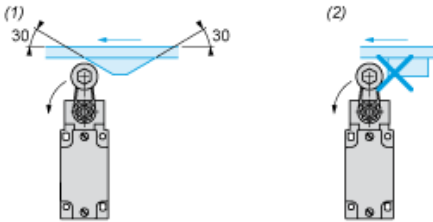

- (1) Recommended
- (2) To be avoided

Setting-up with Head ZCE01 and ZCE09

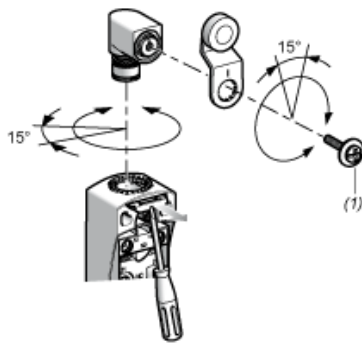

- (1) Tightening torque (Min : 1) (Max : 1.5)

Wiring Diagram

2-pole NC + NO Snap Action

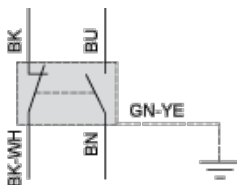

- (BK) Black
- (BK- Black White
WH)
- (BU) Blue
- (BN) Brown
- (GN- Green Yellow
YE)

Characteristics of Actuation

Switch Actuation by 30° Cam

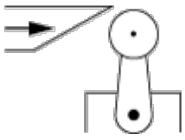

Functional Diagram

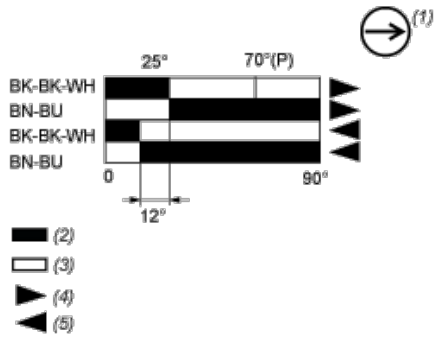

- (P) Positive opening point
- (1) NC contact with positive opening operation
- (2) Closed
- (3) Open
- (4) Tripping
- (5) Resetting
- (BK) Black
- (BK- Black White
WH)
- (BU) Blue
- (BN) Brown